

# METALMASTER

## TREADLE GUILLOTINE OPERATION MANUAL



### Models.

**SG-416A, SG-416S, SG-812**

Order Code S534A, Order Code S534S, Order Code S536

*Edition No* :TG001

*Date of Issue* :07/2018

[www.machineryhouse.com.au](http://www.machineryhouse.com.au)



# OPERATION MANUAL

## MACHINE DETAILS

**MACHINE**

**MODEL NO.**

**SERIAL NO.**

**DATE OF MANF.**

Distributed by



[www.machineryhouse.com.au](http://www.machineryhouse.com.au)

[www.machineryhouse.co.nz](http://www.machineryhouse.co.nz)

**Note:**

This manual is only for your reference. Owing to the continuous improvement of these Metalmaster machine, changes may be made at any time without obligation or notice. Please ensure the local voltage is the same as listed on the specification plate before operating any electric machine.



**NOTE:**

In order to see the type and model of the machine, please see the specification plate. Usually found on the back of the machine. See example (Fig.1)

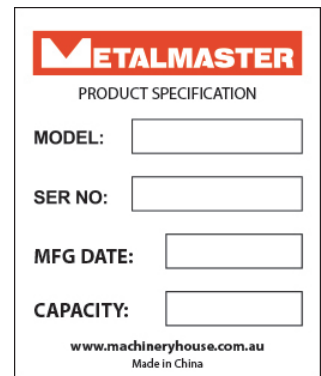

Fig.1



---

## OPERATION MANUAL

---

### CONTENTS:

1. GENERAL MACHINE INFORMATION	
1.1 Specifications.....	4
1.2 Standard Equipment.....	4
1.3 Identification.....	5
2. IMPORTANT INFORMATION	
2.1 Safety Requirements.....	6
2.2 Safety For Metal Cutting Guillotine.....	8
2.3 Lifting Instructions.....	9
3. SETUP	
3.1 Site Preparation.....	10
3.2 Clean Up.....	10
3.3 Options For Mounting.....	10
3.4 Machine Leveling.....	11
3.5 Attaching The Accessories.....	11
4. MAINTENANCE	
4.1 Lubrication And Blade Maintenance.....	12
4.2 Setting Blade Gap.....	13
Spare Parts.....	14
Risk Assessment.....	15



## OPERATION MANUAL

### 1.1 SPECIFICATIONS

Order Code	S534A	S534S	S536
MODEL	SG-416A	SG-416S	SG-812
Shearing Capacity - Mild Steel (mm)	1.6	1.6	1.2
Shearing Capacity - Stainless Steel (mm)	1	1	0.8
Shearing Length (mm)	1300	1300	2470
Shipping Dimensions (L x W x H) (cm)	170 x 56 x 115	170 x 81 x 115	285 x 56 x 115
Table Height (mm)	880	880	880
Footprint (cm)	165 x 95 x 110	165 x 115 x 110	280 x 95 x 110
Nett Weight (kgs)	410	520	800

### 1.2. STANDARD EQUIPMENT

- Back Gauge
- Front Supports
- Finger Guard



**OPERATION MANUAL**

**1.3 IDENTIFICATION**

Become familiar with the names and locations of the controls and features shown below to better understand the instructions in this manual.

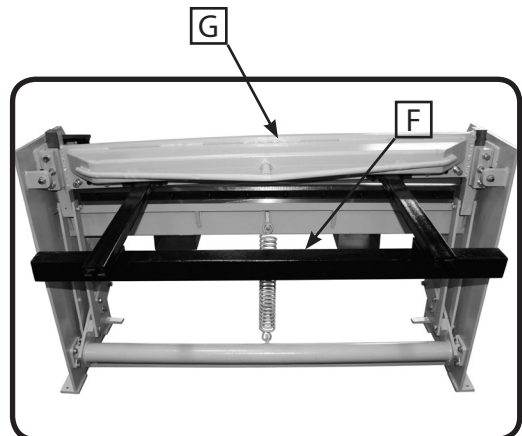
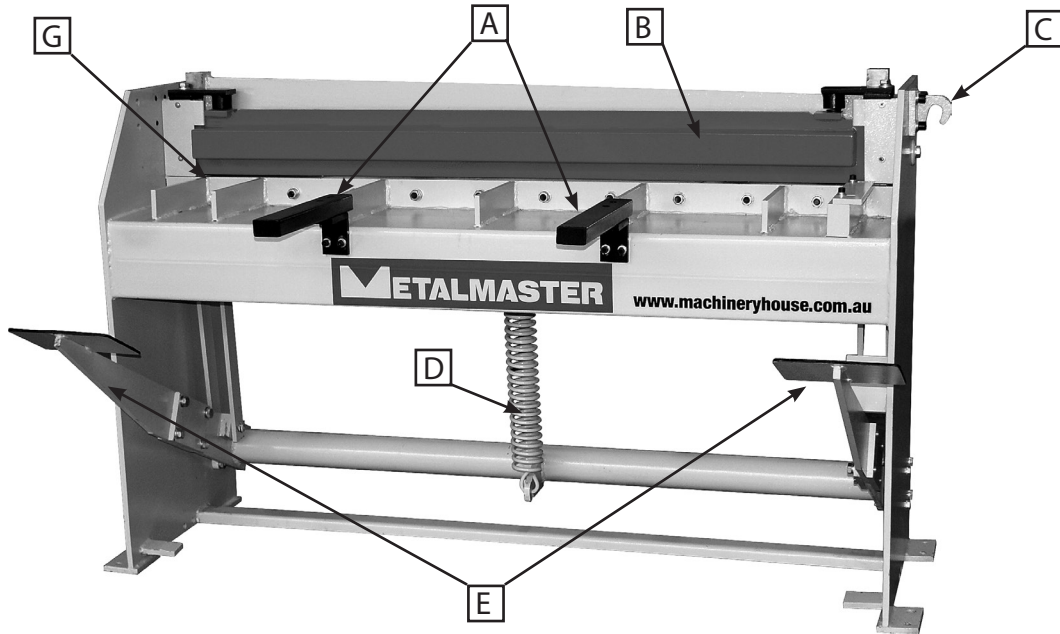

<b>A</b>	Front Sheet Supports	<b>F</b>	Back Gauge
<b>B</b>	Material Clamp	<b>G</b>	Beam
<b>C</b>	Lifting Hooks	<b>H</b>	Bed
<b>D</b>	Return Spring	<b>I</b>	Rear Guard (S534S Only)
<b>E</b>	Foot Pedal		



## OPERATION MANUAL

## 2. IMPORTANT INFORMATION

### 2.1 SAFETY REQUIREMENTS

DO NOT use this machine unless you have read this manual or have been instructed in the use of this machine in its safe use and operation



## WARNING

This manual provides safety instructions on the proper setup, operation, maintenance, and service of this machine. Save this manual, refer to it often, and use it to instruct other operators. Failure to read, understand and follow the instructions in this manual may result in fire or serious personal injury—including amputation, electrocution, or death.

The owner of this machine is solely responsible for its safe use. This responsibility includes, but is not limited to proper installation in a safe environment, personnel training and authorization to use, proper inspection and maintenance, manual availability and comprehension, of the application of the safety devices, integrity, and the use of personal protective equipment.

The manufacturer will not be held liable for injury or property damage from negligence, improper training, machine modifications or misuse.



Safety glasses must be worn at all times in work areas. Earmuffs should be worn if the work area is noisy.



Sturdy footwear must be worn at all times in work areas.



Gloves should NOT be worn when using this machine



Long and loose hair must be contained with a net or under a hat

**OWNER'S MANUAL.** Read and understand this owner's manual before using the machine.

**DISCONNECT POWER FIRST.** If using power, always disconnect the machine from power supply before making adjustments, or servicing the machine. This prevents any risk of injury from unintended startup or contact with live electrical equipment

**TRAINED OPERATORS ONLY.** Operators that have not been trained have a higher risk of being seriously injured. Only allow trained or supervised people to use this machine. When the machine is not being used, disconnect the power, to the machine to prevent unauthorized use—especially around children. Make the workshop safe.



## OPERATION MANUAL

### 2.1 SAFETY REQUIREMENTS Cont.

**WEARING PROPER APPAREL** Do not wear clothing, apparel or jewelry that can become entangled in moving parts. Always tie back or cover long hair. Wear non-slip footwear to avoid accidental slips, which could cause loss of operating control.

**HEARING PROTECTION.** Always wear hearing protection when operating or observing loud machinery. Extended exposure to this noise without hearing protection can cause permanent hearing loss.

**REMOVE ADJUSTING TOOLS.** Tools left on machinery can become dangerous projectiles upon startup. Never leave hex keys, wrenches, or any other tools on machine. Always verify removal before starting!

**USE CORRECT TOOL FOR THE JOB.** Only use this tool for its intended purpose. Do not force the machine or its attachments to do a job for which they were not designed. Never make unapproved modifications. Modifying the machine or using it differently than intended may result in malfunction or mechanical failure that can lead to personal injury or death!

**AWKWARD POSITIONS.** Keep proper footing and balance at all times when operating machine. Do not overreach! Avoid awkward hand positions that make operating control difficult. This could increase the risk of accidental injury

**GUARDS & COVERS.** Guards and covers reduce accidental contact with moving parts or flying debris. Make sure they are properly installed, undamaged, and working correctly.

**FORCING MACHINERY.** Do not force the machine. It will do the job safer and better at the rate for which it was designed.

**NEVER STAND ON MACHINE.** Serious injury may occur if the machine is tipped or if the cutting tool is unintentionally contacted

**STABLE MACHINE.** Unexpected movement during operation greatly increases risk of injury or loss of control. Before starting, verify machine is stable and if using a mobile base it is locked in position.

**UNATTENDED OPERATION.** To reduce the risk of accidental injury, turn the machine OFF and ensure all moving parts have completely stopped before walking away. Never leave the machine running while unattended.

**MAINTAIN WITH CARE.** Follow all maintenance instructions and lubrication schedules to keep the machine in good working condition. A machine that is improperly maintained could malfunction, leading to serious personal injury or death.

**CHECK DAMAGED PARTS.** Regularly inspect the machine for any condition that may affect the safe operation. Immediately repair or replace damaged or parts that are incorrectly fitted before operating.

**CHILDREN & BYSTANDERS.** Keep children and bystanders at a safe distance from the work area. Stop using machine if they become a distraction.



## OPERATION MANUAL

### SAFETY FOR METAL CUTTING GUILLOTINE

**DO NOT** use this machine unless you have been instructed in its safe use and operation and have been given permission

#### PERSONAL PROTECTIVE EQUIPMENT



Safety glasses must be worn at all times in work areas.



Long and loose hair must be contained.



Gloves must not be worn when using this machine.



Sturdy footwear must be worn at all times in work areas.



Close fitting/protective clothing must be worn.



Rings and jewelry must not be worn.

#### PRE-OPERATIONAL SAFETY CHECKS

- Locate and ensure you are familiar with all machine operations and controls.
- Ensure all guards are fitted, secure and functional. Do not operate if guards are missing or faulty.
- Check workspaces and walkways to ensure no slip/trip hazards are present.
- Ensure working parts are well lubricated and free of rust and dirt.
- Ensure the area around the machine is adequately lit.
- Be aware of other people in the area. Ensure the area is clear before using equipment.
- Ensure cutting table is clear of scrap and tools.

#### OPERATIONAL SAFETY CHECKS

- Only one person may operate this machine at any one time.
- Use correct lifting procedures when handling large sheets of material.
- Take care during the initial feeding of the workpiece into the machine.
- The workpiece should always be held sufficiently far back from the edge being fed into the guillotine.
- Ensure fingers and limbs are clear before operating the guillotine.
- Hold material firmly to prevent inaccurate cutting due to creep.
- When cutting, ensure your feet are positioned to avoid unintentional contact with the foot operated lever

#### DON'T

- Do not use faulty equipment. Immediately report suspect machinery.
- Never attempt to cut rod, strap or wire.
- Do not attempt to cut material beyond the capacity of the machine.

#### HOUSEKEEPING

- Place all off-cuts in the storage rack or waste bin.
- Leave the work area in a safe, clean and tidy state.

#### POTENTIAL HAZARDS

- Sharp edges and burrs.
- Crush and pinch points.
- Manual handling.





# OPERATION MANUAL

## 2.3 LIFTING INSTRUCTIONS

On the day that the machine arrives, make sure that a crane with sufficient capacity is available to unload the machine from the vehicle. Ensure access to the chosen site is clear and that doors and ceilings are sufficiently high and wide enough to receive the machine.

To handle the Guillotine, use only the two sling lifting points located on the top of the end plates. (Fig. 2.3) The slings should be positioned so the machine is level when lifted.

When using slings please take note of the sling angle and the loads that apply

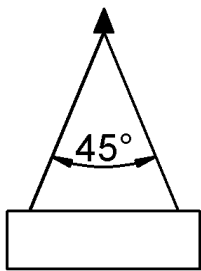

Fig 2.1.

When the slings are at a 45° angle then each sling is carrying the equivalent of 50% of load weight. (Fig.2.1).

When the slings are at a 90° angle then each sling will have a weight equal to 75% of the load on each sling. (Fig 2.2)

**NOTE:** Metalmaster recommend not to exceed 90° angle

Fig 2.2

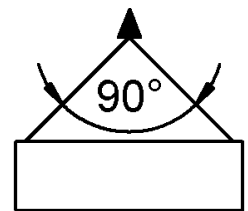

## LIFTING POINTS

The machines listed in this manual are fitted with two designated lifting points.

When lifting the machine only certified lifting slings should be used. (Fig. 2.4) Ensure that when lifting, the machine does not tip over. Check that the lifting slings do not interfere with any fragile parts of the machine. Failure to follow these instruction could cause damage to the machine



**WARNING**

Lifting machinery is dangerous and should be carried out by people who are experienced and are authorized to work with the crane and the slings.

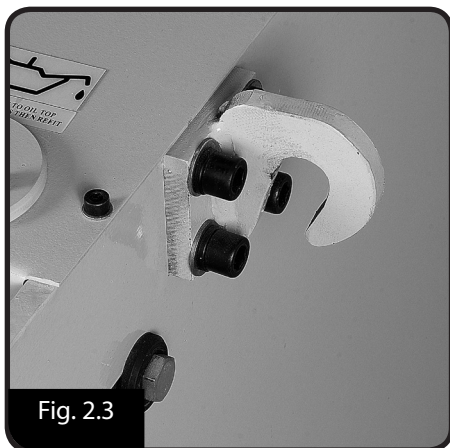

Fig. 2.3

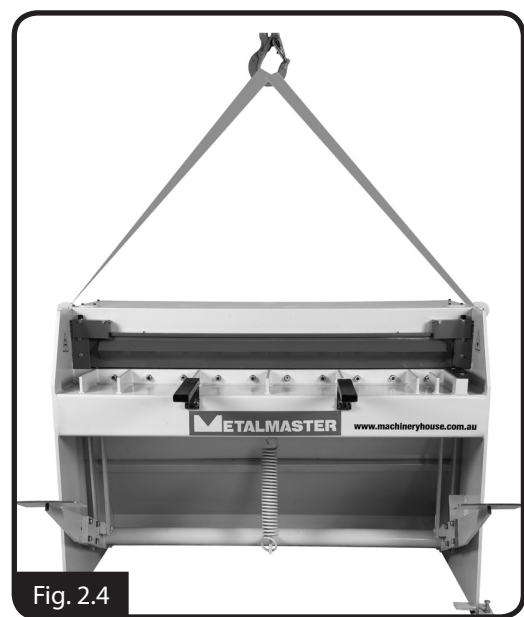

Fig. 2.4



## OPERATION MANUAL

### 3. SETUP

#### 3.1 SITE PREPARATION

When selecting the site for the machine, consider the largest size of workpiece that will be processed through the machine and provide enough space around the machine for operating the machine safely. Consideration should be given to the installation of auxiliary equipment. Leave enough space around the machine to open or remove doors/covers as required for the maintenance and service as described in this manual.

It is recommended that the machine is anchored to the floor to prevent tipping or shifting. It also reduces vibration that may occur during operation. The floor must be able to support the weight of the machine and any workpiece that is to be worked.

#### 3.2 CLEAN - UP

The unpainted surfaces of the machine have been coated with a waxy oil to protect them from corrosion during shipment. Remove the protective coating with a solvent cleaner or a citrus based degreaser.

Optimum performance from your machine will be achieved when you clean all moving parts or sliding contact surfaces that are coated with rust prevented products.

Metalmaster advise to avoid chlorine based solvents, such as acetone or brake parts cleaner, as they will damage painted surfaces should they come in contact. Always follow the manufacturer's instructions when using any type of cleaning product.

#### 3.3 OPTIONS FOR MOUNTING

The machine is best mounted on a concrete slab. Masonry anchors with bolts are the best way to anchor the machinery, because the anchors sit flush with the floor surface, making it easy to unbolt and move the machine later, if needed. (Fig. 3-1)

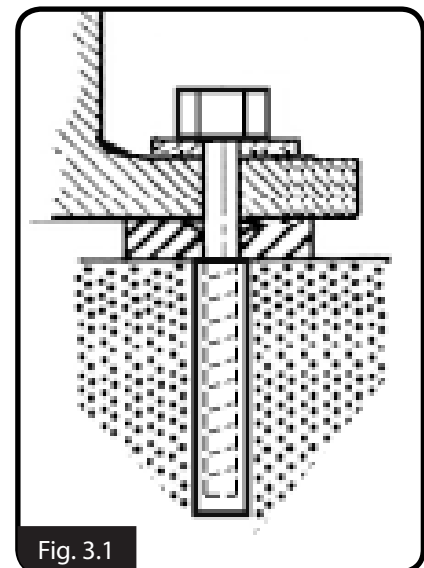

Fig. 3.1

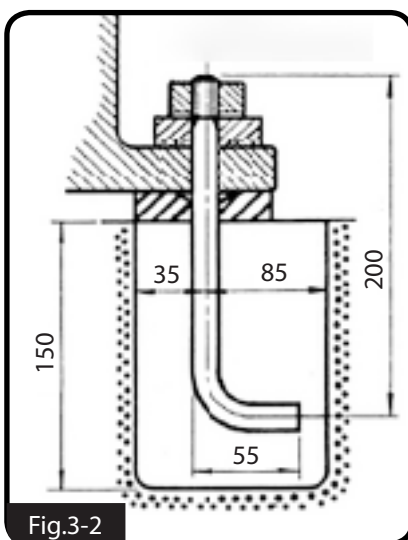

Fig.3-2

In some case a suitable foundation may not be available and a new one may need to be prepared.

The foundation should be concrete approximately 150mm thick with pockets left clear for the hold down bolts. The hold down bolts can be "L" shape as per the example in Fig. 3-2

# METALMASTER

## OPERATION MANUAL

### 3.4 MACHINE LEVELING

To set your machine up so that it operates to optimum performance, apply the following procedure

After your guillotine has been anchored to a concrete slab floor, it then needs to be leveled. The leveling is performed using each of the screws on each pad.(Fig. 3.1). Loosen the hold down bolts and place a level on the surface of the working table. Tolerances: 1000:0.30mm, for both longitudinal and transverse.

Metal plates need to be placed under each jacking screw to distribute the load. Once level then tighten the hold down bolts.

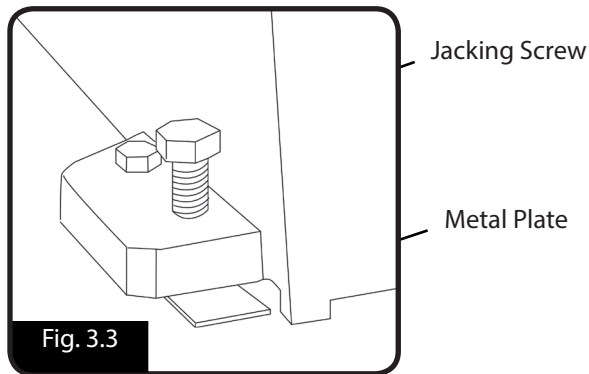

Fig. 3.3



The machine must not rest on supports other than those defined in Fig. 3.2

### 3.5 ATTACHING THE ACCESSORIES.

- Bolt the support arms onto the feed table. Ensure they are level and square to the table. (Fig.3.4)



Fig. 3.4

- Place the squaring stop Fig 3.5 into position on the table top, securing into place with the bolts supplied. Check that the square stop is square to the blade. Adjust by loosening the bolts and moving by the amount allowed by the clearance of the holes.
- Re tighten the screws.

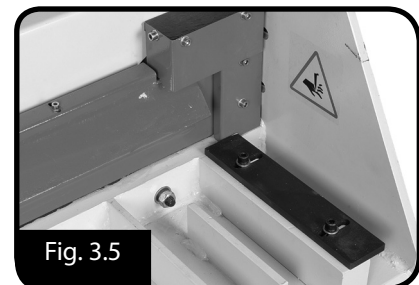

Fig. 3.5

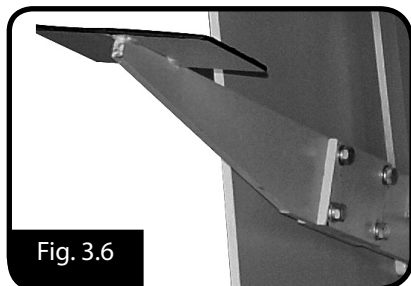

Fig. 3.6

- Unpack and attach the two foot pedals and attach with the 4 bolts supplied. (Fig.3.6)



## OPERATION MANUAL

### 4. MAINTENANCE

For optimum performance from your machine, follow this maintenance schedule and refer to any specific instructions given in this section.

#### Daily Checks and Maintenance:

- Loose mounting bolts.
- Lubrication levels.
- Safety guards are on and secure
- Any other unsafe condition

#### 4.1 LUBRICATION AND BLADE MAINTENANCE

- a. The moving parts of the machine should be oiled and greased daily.
- b. The shearing blade should be cleaned and oiled
- c. All waste material should be moved from the cutting surface.

SG-416A & SG-812

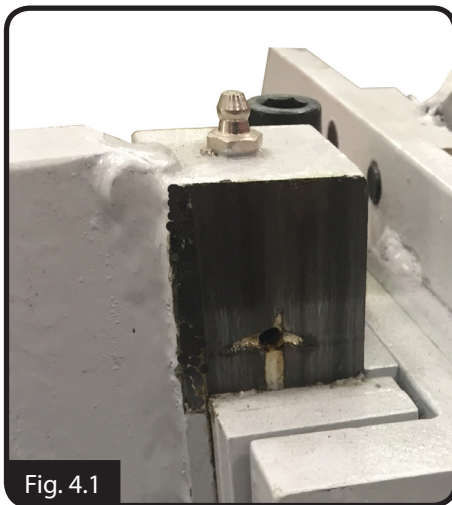

Fig. 4.1

SG-416S

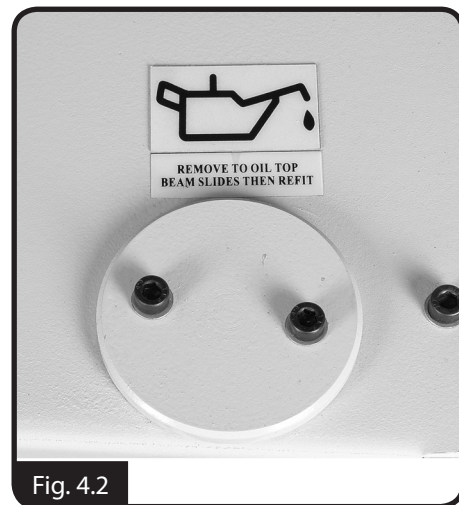

Fig. 4.2

No.	Part	Lubrication	Period (Days)
1.	Slip Plate	Grease	7
2.	Pin	N32 Machine Oil	30
3.	Rotating Shaft Bearing	Grease	90

# METALMASTER

## OPERATION MANUAL

### 4.2 SETTING THE BLADE GAP

After prolong use the gap between the blades need to be checked. Firstly check the cutting capacity of the guilotine. This can be found on the specification plate on the machine. (Fig. 4.3)The capacity listed is for Mild Steel. Stainless steel capacity can be found in the specification table in this manual. (Page 4)

#### Check The Blade Gap Setting

The machine is supplied from the factory with the blade gap set for the capacity of the machine.

The blade gap should be approximately 10% of the thickness of the capacity

E.G. 1.6mm material = 0.16mm Blade Gap

#### To Check the Gap



#### WARNING

**Only experienced service personnel should attempt this operation. Care needs to be taken not to place fingers between the blades at any time to prevent serious injury or amputation.**

1. Place a "Out Of Service" tag on the front of the machine so that is clearly displayed.
2. Press down the foot pedal until it reaches the bottom position, then clamp the pedal as shown in Fig.4.4
3. From the back of the machine using a feeler gauge check the gap between the blades, several places along the length of the blades.

#### To adjust the blade gap.

1. Place a "Out Of Service" tag on the front of the machine so that is clearly displayed.
2. Loosen the 4 bolts (A in Fig.4.5) on both sides of the machine. The bolts should be only loosened enough to allow the blade to move.
3. Using the adjustment nuts (B in Fig.4.6). Adjust the blade until the correct gap is set.

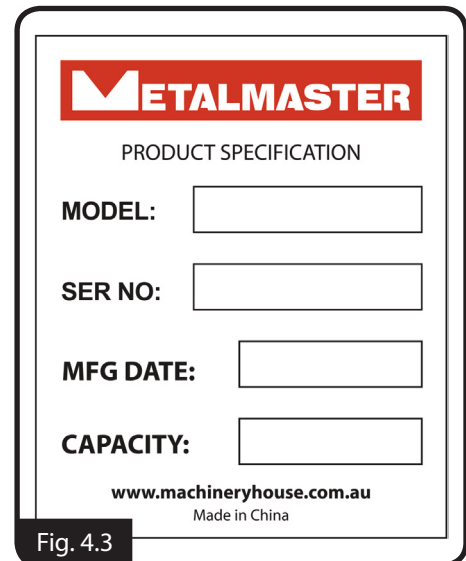

Fig. 4.3



Fig. 4.4

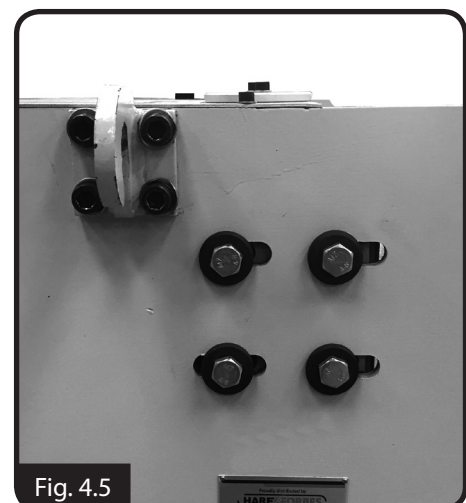

Fig. 4.5



## OPERATION MANUAL

### 4.2 SETTING THE BLADE GAP Cont.

4. Tighten the 4 bolts on the outside of the side plates on both sides of the machine. (A in Fig.4.5)
5. Check the gap again by the method displayed on Page.13
6. If adjustment is still required repeat steps 2-4

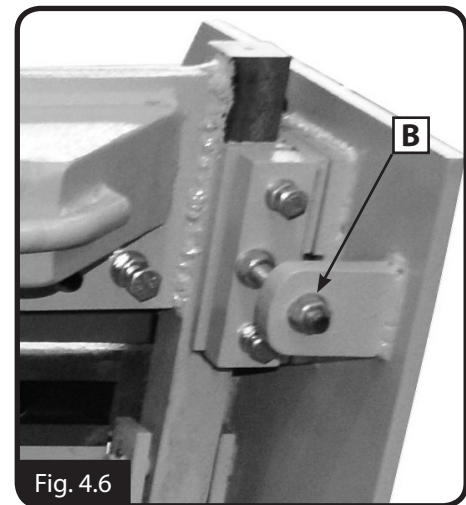

Fig. 4.6

# SPARE PARTS SECTION

The following section covers the spare parts diagrams and lists that were current at the time this manual was originally printed. Due to continuous improvements of the machine, changes may be made at any time without notification.

### HOW TO ORDER SPARE PARTS

1. Have your machines **model number, serial number & date of manufacture** on hand, these can be found on the specification plate mounted on the machine
2. A scanned copy of your parts list/diagram with required spare part/s identified
3. Go to [www.machineryhouse.com.au/contactus](http://www.machineryhouse.com.au/contactus) and fill out the enquiry form attaching a copy of scanned parts list.

ITEM CODE	PART NO.	DESCRIPTION
S9981	GB-132.6020	Top & Bottom Blade Set 9CrSi Guillotine SG-416A, SG416S
S9982	GB-127.6020	Top & Bottom Blade Set 9CrSi Guillotine SG-812
2HY0001		Spring SG-416A, SG-812



# WARNING

## General Machinery Safety Instructions

---

Machinery House  
requires you to read this entire Manual before using this machine.

- 1. Read the entire Manual before starting machinery.** Machinery may cause serious injury if not correctly used.
- 2. Always use correct hearing protection when operating machinery.** Machinery noise may cause permanent hearing damage.
- 3. Machinery must never be used when tired, or under the influence of drugs or alcohol.** When running machinery you must be alert at all times.
- 4. Wear correct Clothing.** At all times remove all loose clothing, necklaces, rings, jewelry, etc. Long hair must be contained in a hair net. Non-slip protective footwear must be worn.
- 5. Always wear correct respirators around fumes or dust when operating machinery.** Machinery fumes & dust can cause serious respiratory illness. Dust extractors must be used where applicable.
- 6. Always wear correct safety glasses.** When machining you must use the correct eye protection to prevent injuring your eyes.
- 7. Keep work clean and make sure you have good lighting.** Cluttered and dark shadows may cause accidents.
- 8. Personnel must be properly trained or well supervised when operating machinery.** Make sure you have clear and safe understanding of the machine you are operating.
- 9. Keep children and visitors away.** Make sure children and visitors are at a safe distance for you work area.
- 10. Keep your workshop childproof.** Use padlocks, Turn off master power switches and remove start switch keys.
- 11. Never leave machine unattended.** Turn power off and wait till machine has come to a complete stop before leaving the machine unattended.
- 12. Make a safe working environment.** Do not use machine in a damp, wet area, or where flammable or noxious fumes may exist.
- 13. Disconnect main power before service machine.** Make sure power switch is in the off position before re-connecting.
- 14. Use correct amperage extension cords.** Undersized extension cords overheat and lose power. Replace extension cords if they become damaged.
- 15. Keep machine well maintained.** Keep blades sharp and clean for best and safest performance. Follow instructions when lubricating and changing accessories.
- 16. Keep machine well guarded.** Make sure guards on machine are in place and are all working correctly.
- 17. Do not overreach.** Keep proper footing and balance at all times.
- 18. Secure workpiece.** Use clamps or a vice to hold the workpiece where practical. Keeping the workpiece secure will free up your hand to operate the machine and will protect hand from injury.
- 19. Check machine over before operating.** Check machine for damaged parts, loose bolts, Keys and wrenches left on machine and any other conditions that may effect the machines operation. Repair and replace damaged parts.
- 20. Use recommended accessories.** Refer to instruction manual or ask correct service officer when using accessories. The use of improper accessories may cause the risk of injury.
- 21. Do not force machinery.** Work at the speed and capacity at which the machine or accessory was designed.
- 22. Use correct lifting practice.** Always use the correct lifting methods when using machinery. Incorrect lifting methods can cause serious injury.
- 23. Lock mobile bases.** Make sure any mobile bases are locked before using machine.
- 24. Allergic reactions.** Certain metal shavings and cutting fluids may cause an allergic reaction in people and animals, especially when cutting as the fumes can be inhaled. Make sure you know what type of metal and cutting fluid you will be exposed to and how to avoid contamination.
- 25. Call for help.** If at any time you experience difficulties, stop the machine and call you nearest branch service department for help.



# Manual Guillotine Safety Instructions

---

Machinery House  
requires you to read this entire Manual before using this machine.

- 1. Maintenance.** Make sure all moving parts are locked down before any inspection, adjustment or maintenance is carried out. Place a block of timber between the blades to save blades from shearing hands or fingers.
- 2. Guillotine Condition.** Guillotine must be maintained for a proper working condition. Never operate a Guillotine that has damaged or worn parts. Scheduled routine maintenance should be performed on a scheduled basis.
- 3. Blade Condition.** Never operate a Guillotine with a damaged or badly worn blade. Replace if required.
- 4. Hand Hazard.** Keep hands and fingers clear from moving parts. Serious injury can occur if hand or finger tips come between blades.
- 5. Personal Protection.** Gloves are recommended when handling the workpieces.
- 6. Authorized and trained personnel.** The machine must be operated by authorized and trained personnel. The shear is designed to be operated by a single user. Using the machine with more than one operator is forbidden, except for certain maintenance situations.
- 7. Work area hazards.** Keep the area around the Guillotine clean from oil, tools, objects & chips. Pay attention to other persons in the area and know what is going on around the area to ensure unintended accidents.
- 8. Guards.** Do not operate Guillotine without the correct guards in place. Necessary guards protect you from injuries by the shear blades.
- 9. Material.** Material must NOT be hardened ceramic or glass-originated, non flat metals (at origin) e.g. rods, bars, tubes & pipes.
- 10. Blade gap adjustment.** Do NOT operate the machine without proper blade gap adjustment according to sheet thickness.
- 11. Warning Labels.** Take note of any warning labels on the machine and do not remove them.
- 12. Backgauge Area.** Do not access the backgauge area, while the machine is working.
- 13. Squaring arm.** Do not use side squaring arm and front support arms for intermediate storage of workpieces.
- 14. Operation.** During the shearing process, the workpiece may slide or move unexpectedly. Therefore, the material must be handled carefully.
- 15. Level machine.** Level the machine on a flat concrete surface by using a spirit level.
- 16. Hearing protection and hazards.** Always wear hearing protection as noise generated from machine and workpiece can cause permanent hearing loss over time.
- 17. Call for help.** If at any time you experience difficulties, stop the machine and call your nearest branch service department for help.



# PLANT SAFETY PROGRAM

## **NEW MACHINERY HAZARD IDENTIFICATION, ASSESSMENT & CONTROL**

### **Manual Guillotine**

Developed in Co-operation Between A.W.I.S.A and Australia Chamber of Manufactures  
 This program is based upon the Safe Work Australia, Code of Practice - Managing Risks of Plant in the Workplace ( WHSA 2011 No10 )

Item No.	Hazard Identification	Hazard Assessment	Risk Control Strategies <small>(Recommended for Purchase / Buyer / User)</small>
B	CRUSHING	LOW	Secure & support work material on table.
C	CUTTING, STABBING, PUNCTURING	MEDIUM	Wear gloves to prevent cuts from sharp material offcuts.
D	SHEARING	MEDIUM	Hands should be kept clear of moving parts and blades. Ensure front blade guard is fitted securely. Do not adjust or clean machine while operating.
F	STRIKING	MEDIUM	Wear safety glasses. Stand clear of falling offcuts. Ensure material hold downs are correctly adjusted. Ensure guards are secured properly.
O	OTHER HAZARDS, NOISE.	LOW	Wear hearing protection as required.
Plant Safety Program to be read in conjunction with manufactures instructions			



[www.machineryhouse.com.au](http://www.machineryhouse.com.au)



[www.machineryhouse.co.nz](http://www.machineryhouse.co.nz)

Authorised and signed by:  
 Safety officer:

  
 Manager:

.....

Revised Date: 12th March 2012